

Varenummer: 201651V502SW
 Beskrivelse: E+G Rørholder - GN 165.1-V50-2-SW

Mål

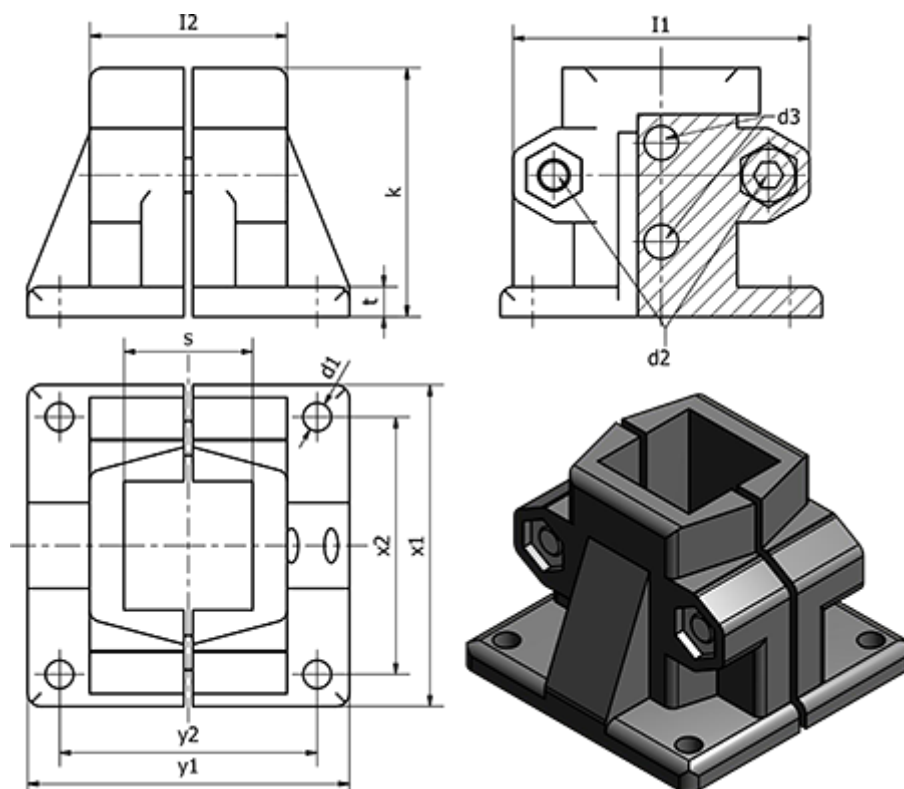

d1	= 11	t	= 14
d2	= M10	Vægt (g)	= 840
d3	= M6	x1	= 115
Fastspændings kit for d2	= GN 911-M10-55	x2	= 90
l1	= 98	y1	= 119
l2	= 70	y2	= 90
k	= 91		
s	= V50		